

Networking Technologies and Applications

Rolland Vida
BME TMIT

October 14, 2020



Why fiber?

- Today the killer application is not web browsing anymore, but multimedia
 - MPEG-1 – ISO/IEC standard
 - Moving Pictures Experts Group
 - 50:1 – 100:1 compression rate
 - 1.5 Mbps, VHS quality image
 - MPEG-2
 - DVD quality image
 - High resolution, high color depth, high movement video (e.g., sport events) – 4-8 Mbps
 - HDTV – 14 Mbps, **8K UHD TV – 50 Mbps** (7680 x 4320, 60 fps)
- The ADSL speeds are far from being enough
 - Only in case of very short loops

Why fiber?

- HFC (Hybrid Fiber Coax)
 - The traditional 300-550 MHz coaxial cables replaced with 850 MHz cables
 - Additional 300 MHz → 50 new 6 MHz wide channels
 - With QAM-256, 40 Mbps per channel → 2 Gbps new bandwidth
 - 500 houses on a segment → each subscriber gets 4 Mbps downstream, which might be enough for an MPEG-2 stream
 - Sounds nice, but...
 - All the cables should be changed to 850 MHz coax
 - New CMTS, new fiber nodes, two-way amplifiers
 - Nearly the entire network has to be changed
- Why not bringing the fiber as close to the subscriber as possible?

Slow speed is today a torture!

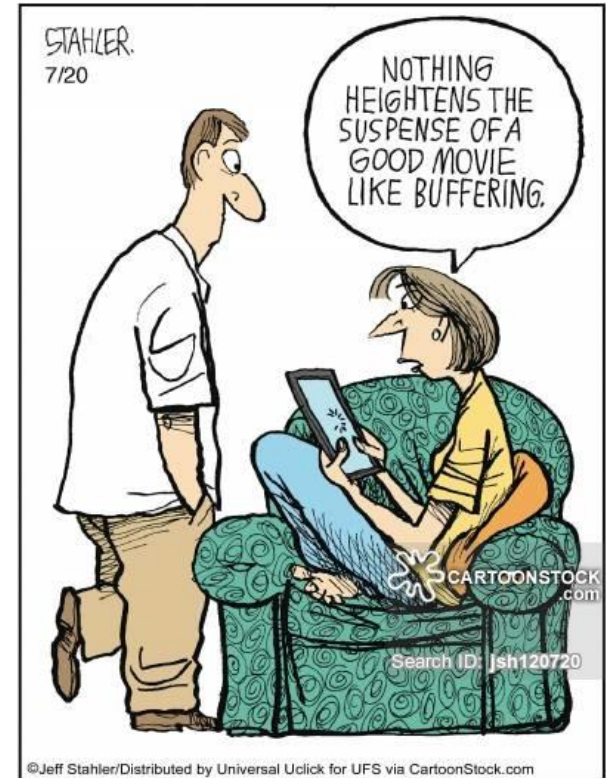
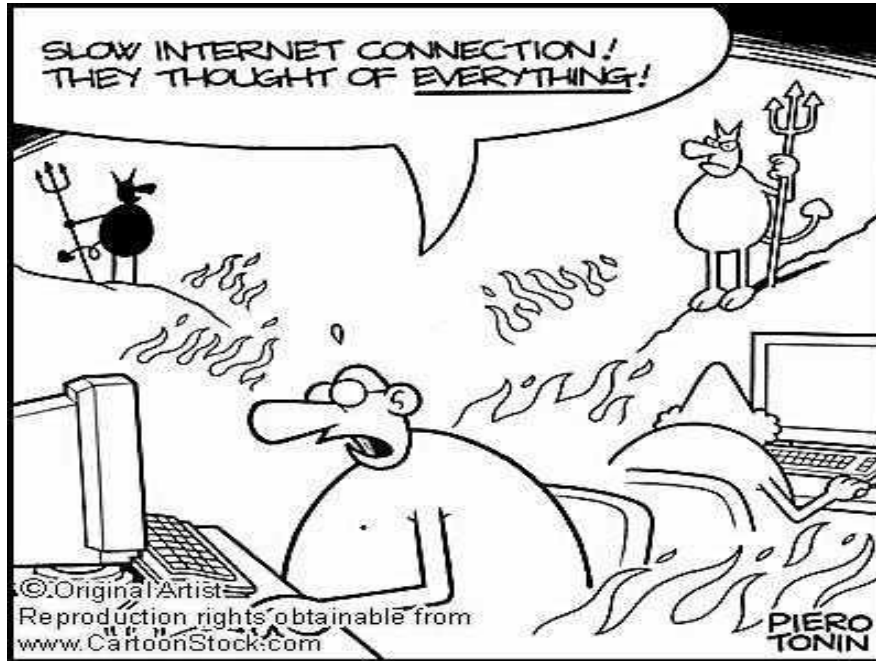

Speed is important!

Estimated minimum download time for the Braveheart movie

MGM, Paramount Pictures, Warner Brothers and Universal Studios announce a common plan to support on-line movie renting”

2002 december 9

„Hollywood’s Latest Flop”, Fortune Magazine:

„The data files are huge. At 952 megabytes, Braveheart took just less than five hours to download using our DSL line at home. Video-on-demand? Hardly. In the same time we could have made 20 roundtrips to our neighborhood Blockbuster”

Technology	Minutes	Hours	Days
Modem 56 kb/s			2
		12	
DSL 1 Mb/s		2.5	
Cable 2.5 Mb/s		1	
	45		
FTTH	0.4		

Data transfer over the fiber

- Three main components:
 - Source of light
 - LED (light emitting diode), laser
 - Fiber
 - Very thin glass fiber
 - Light detector
- The digital data has to be transformed to light pulses, and vice versa
- The transfer speed is only limited by the speed of the conversion
 - Actual speeds today on a single fiber ~10-50 Gbps

Fiber categories

- Multi-mode fiber

- Light pulses are spread inside the fiber
- Many rays of light reflected under different angles
- Cheap solution, but suitable only for small distances (500 m)



- Single-mode fiber

- The diameter of the fiber is very small, a single ray of light is transmitted inside the fiber, no reflections
- Much more expensive, needs much higher capacity lasers
- Suitable for much larger distances
 - 50 Gbps on 100 km without amplifiers
 - Very important for transatlantic cables, where amplifiers are hard to install
- The core network is built only with single-mode fibers

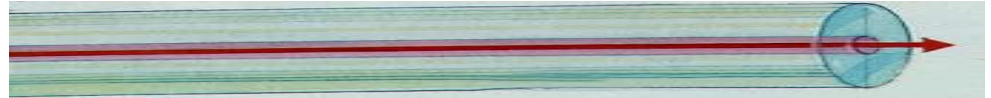

Submarine optical systems

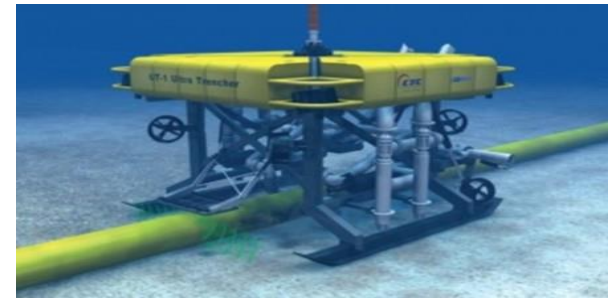
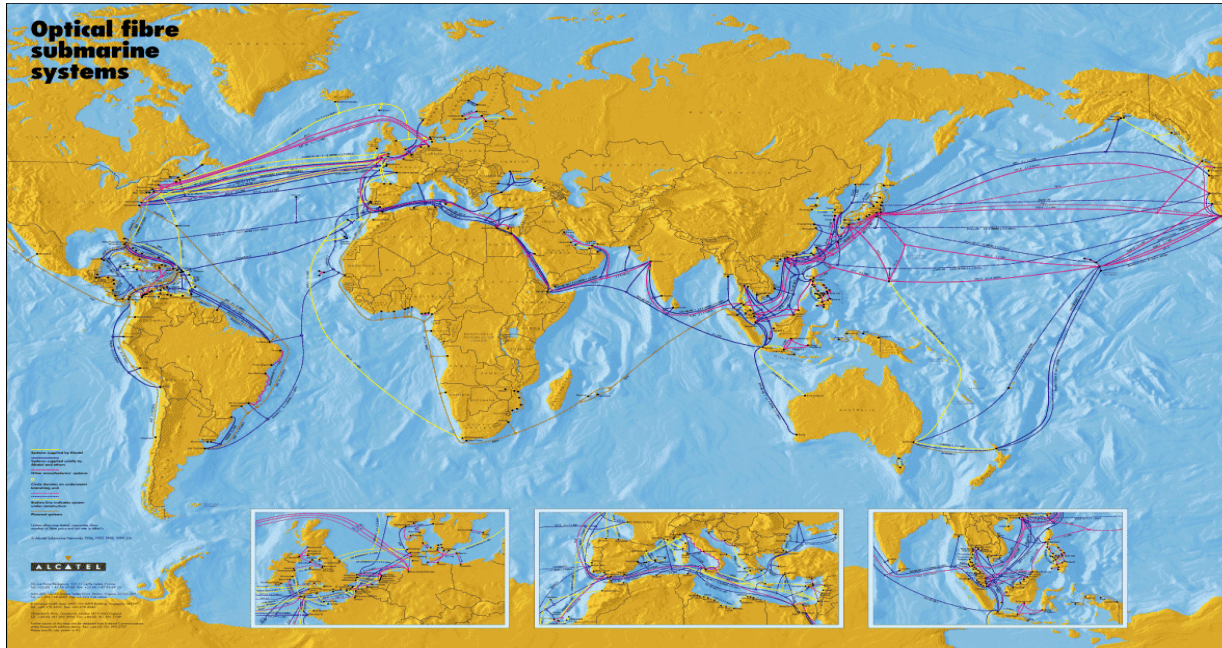

Fiber vs. Copper

- On an optical fiber more than **2.5 million** parallel phone calls
- Compared to a similar capacity bundle of twisted pair connections, 1% in weight and size

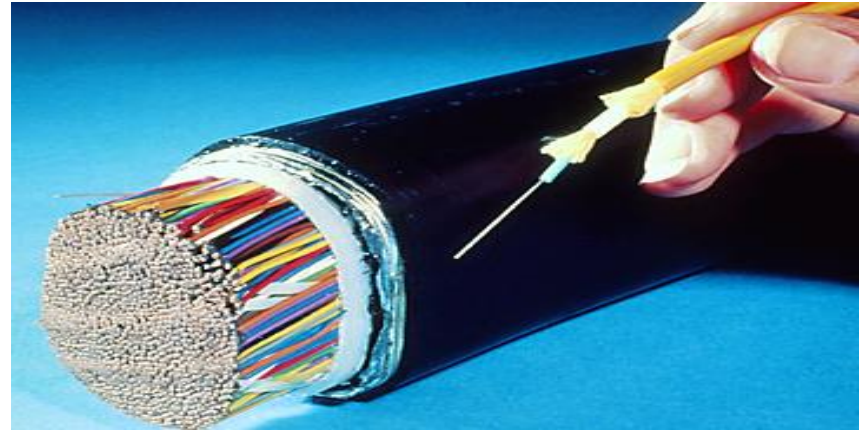

Fiber vs. Copper

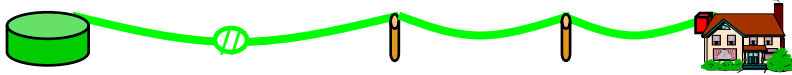

- Optical fiber

- Transports light pulses
- Not influenced by electromagnetic interferences
- Repeaters after ~30 kms
- Low dilatation
- Fragile, quite rigid material
- Chemically stable

- Copper twisted pair

- Transports electric waves
- Sensible to electromagnetic interferences
- Repeaters after 5 km
- Dilatation in case of high temperatures
- Can be bended
- Sensible to galvanic reactions
- Can be reused
 - The copper could be sold

FTTx

- FTTx – Fiber To The x
 - FTTB – Fiber To The Building
 - FTTC – Fiber To The Curb
 - FTTD – Fiber To The Desk
 - FTTE – Fiber To The Enclosure
 - **FTTH – Fiber To The Home**
 - FTTN – Fiber To The Neighborhood
 - FTTO – Fiber To The Office
 - FTTP – Fiber To The Premises
 - FTTU – Fiber To The User

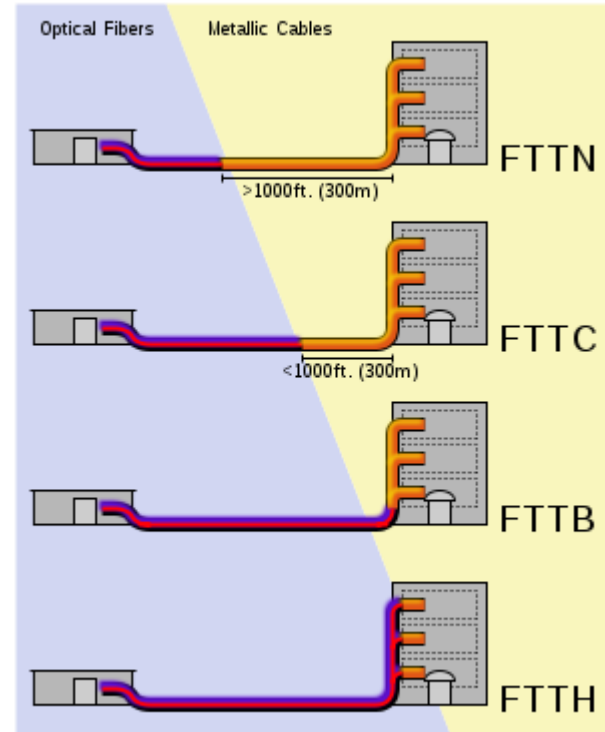

FTTC

- **Fiber To The Curb**
- Fiber from the local switching center near to the homes
 - The connection terminated by an ONU
 - Optical Network Unit
 - Many twisted pairs or coaxial cables added in the „last mile”
 - Very short loops, can be extended with a DSL segment
 - e.g., VDSL – very popular in South-East Asia
 - Suitable for MPEG-2 streams and videoconferencing

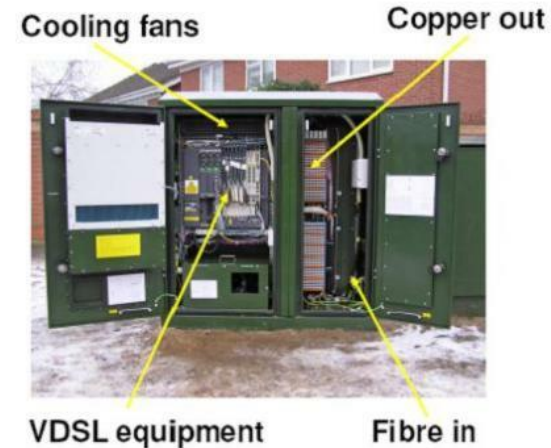

FTTH

- Fiber To The Home
- System components
 - OAN: Optical Access Network
 - ONU/ONT: Optical Network Unit/Terminal
 - At the subscriber
 - OLT: Optical Line Termination
 - At the service provider

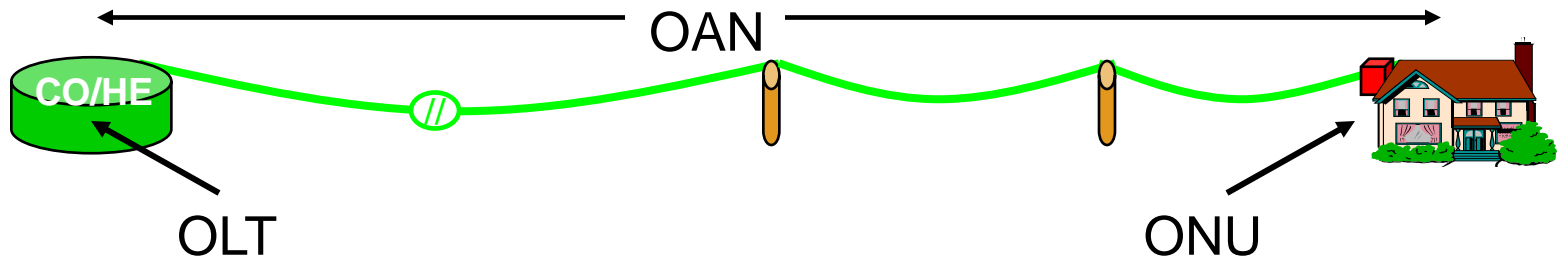

FTTH architectures



- PON – Passive Optical Networks
 - Many subscribers (max. 32) share an optical fiber
 - Optical splitters to separate or aggregate the signals to/from different subscribers
 - No need for power supply for the splitters
 - Shared network – Point to Multipoint (P2MP)

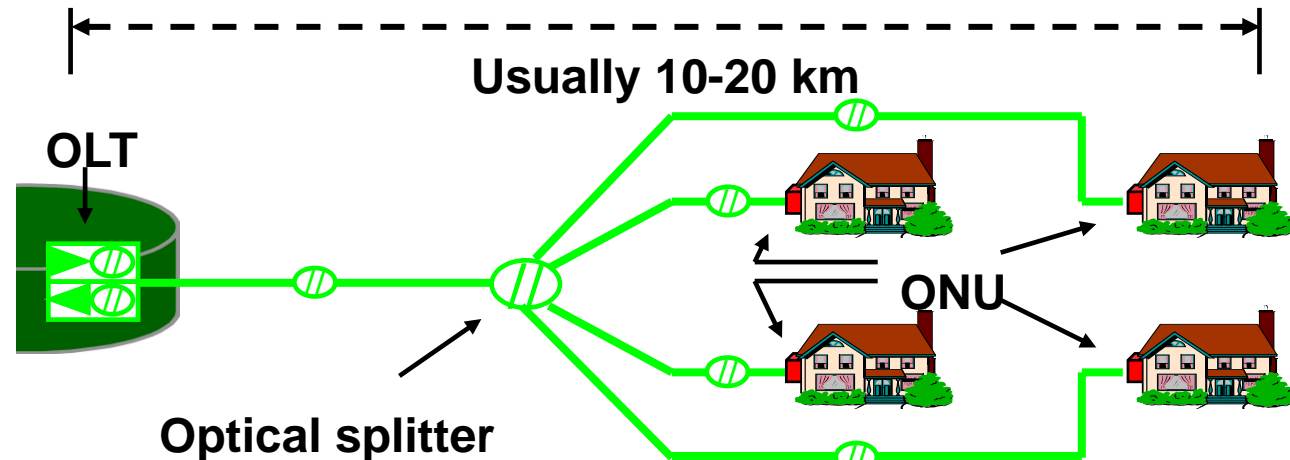

FTTH architectures

- Active Node
 - Each subscriber has his own optical fiber
 - Point to Point (P2P)
 - Active, powered nodes to separate the traffic
 - Ethernet switch
 - Layer2/Layer3 switching/routing

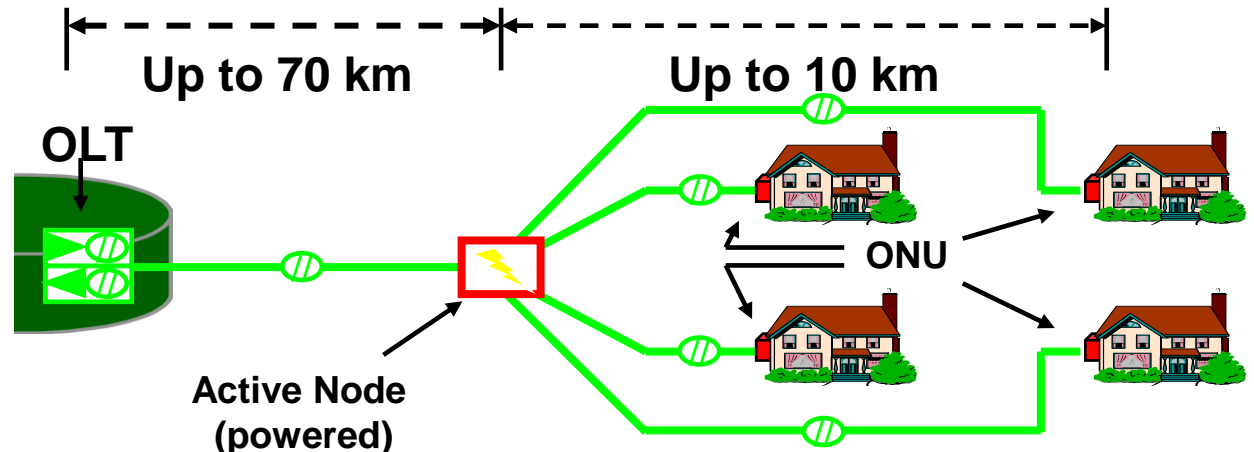

FTTH architectures

- Hybrid PON
 - A combination of the two architectures

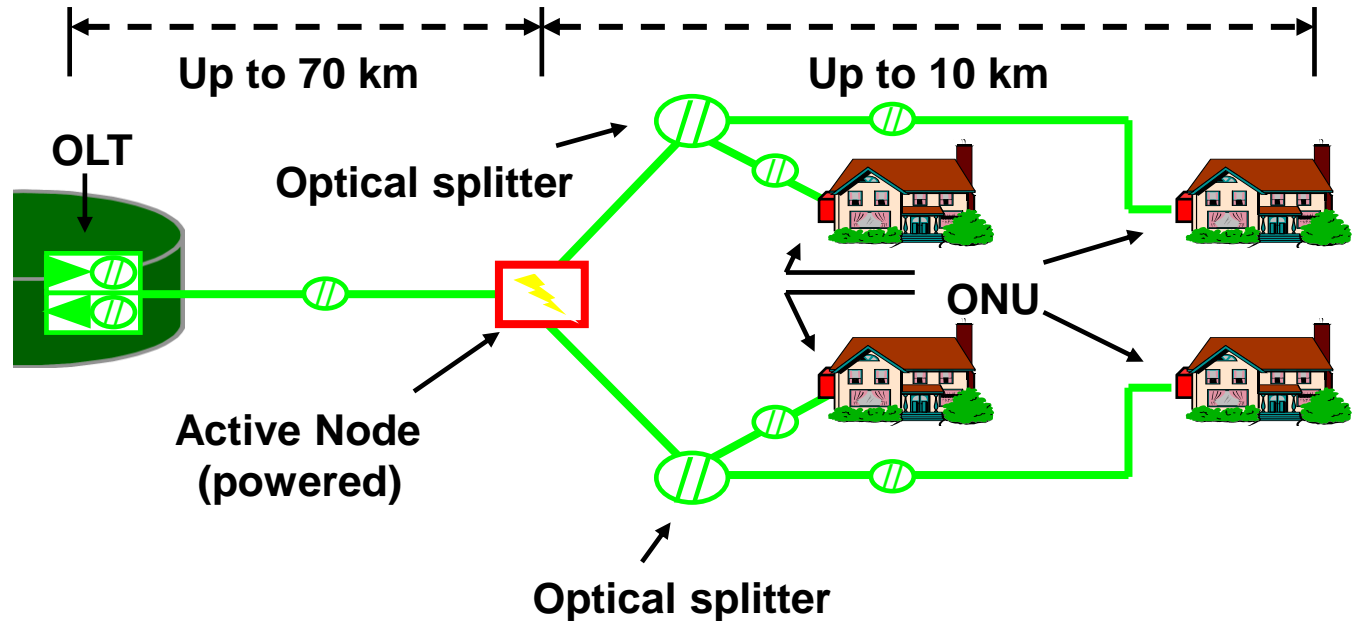

PON - upstream and downstream traffic

- The upstream and downstream traffic handled differently
 - Broadcast downstream
 - The splitter forwards all the data to all the connected segments
 - The ONU handles only the packets that it is the destination of (based on the header)
 - Upstream traffic with TDMA
 - The OLT assigns time slots to the ONUs
 - Synchronized sending of packets
 - The ONU can ask for further slots, if needed

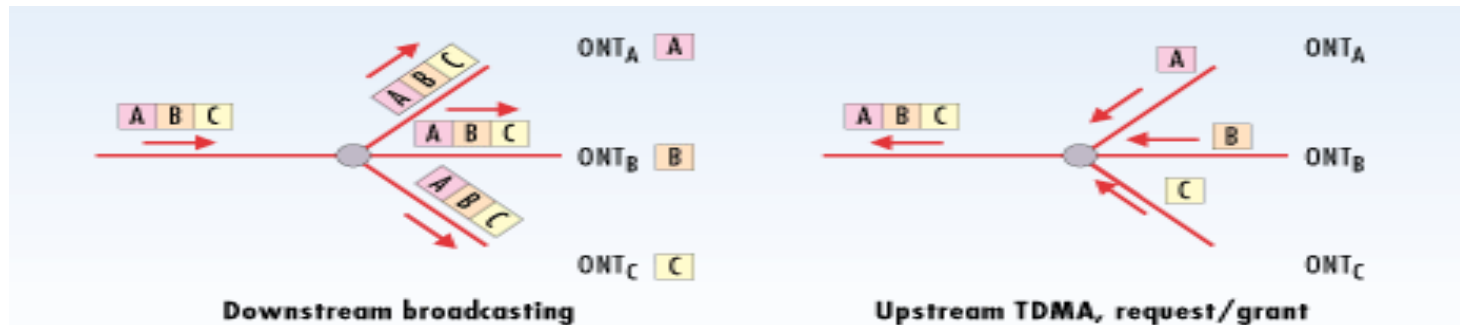

Ethernet or ATM?

- At the beginning, two concurrent technologies
 - APON – ATM-based PON
 - The first PON implementation
 - EPON – Ethernet-based PON

ATM (Asynchronous Transfer Mode)

- Proposed for parallel handling of different traffic types (audio, video, data)
 - 1500 byte Ethernet frames are too large
 - 1.500 byte = 12.000 bit
 - On 10 Mbps Ethernet 0.1 μ s bit time \rightarrow 1.2 ms / frame
 - If more sources (stations or applications) are waiting in a queue, too long waiting times
- Audio and video applications have strict **delay** and **jitter** requirements

ATM (Asynchronous Transfer Mode)

- ATM solution
 - Fixed size **ATM cells**: 5 byte header + 48 byte data = **53 byte**
 - **Segmentation and Reassembly (SAR)**
 - Variable length frames are fragmented at the sender, and reassembled at the receiver, based on the header
 - **Asynchronous Time Division Multiplexing**

ATM (Asynchronous Transfer Mode)

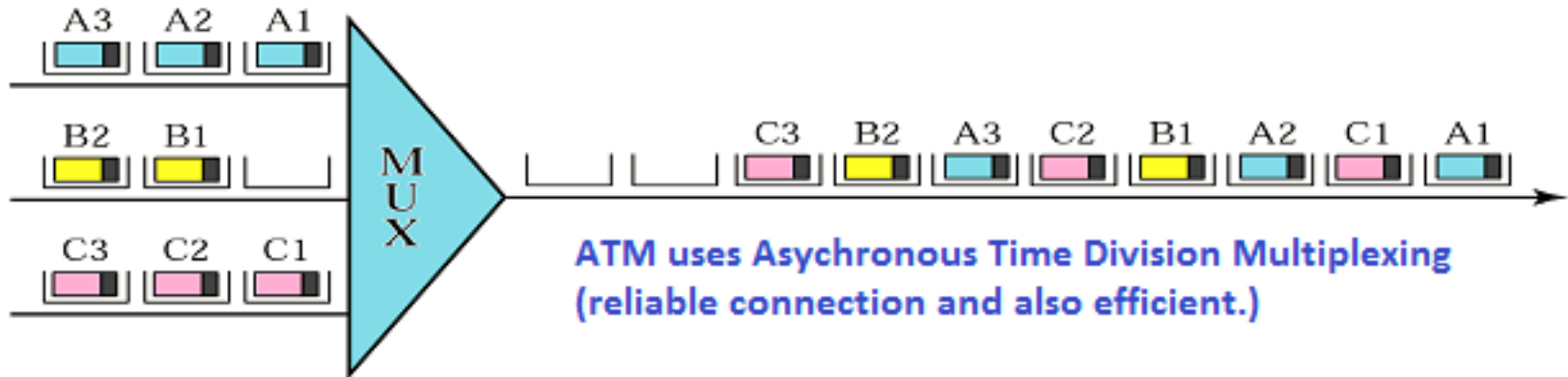
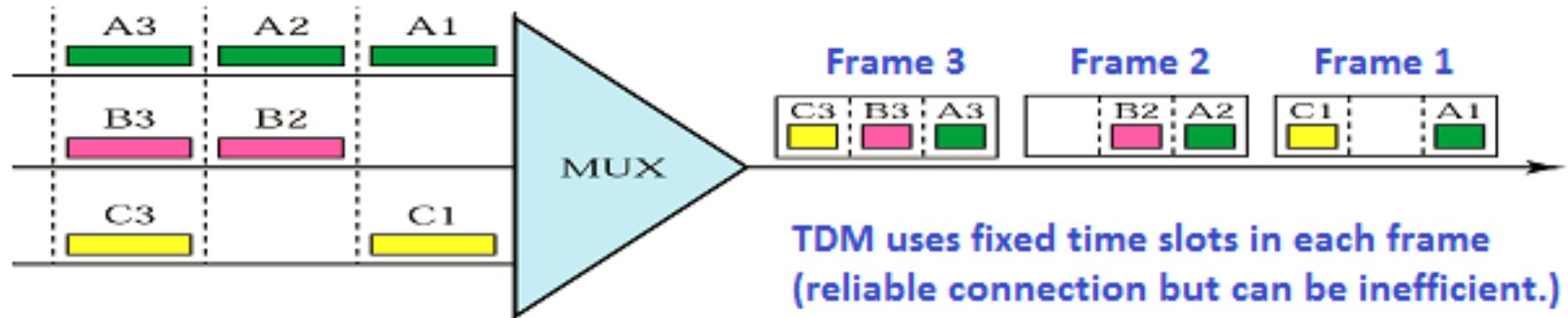

APON

- **Segmentation and Reassembly (SAR)**
 - Fix sized packets
 - 53 byte long ATM cells
 - Data passes through an ATM Adaptation Layer-en (AAL), where it is split in 48 byte long packets
 - Plus 5 byte long headers
 - Packets are reassembled at the destination
- Because of the SAR, ATM is very suitable for video and voice transfer
 - Delay-sensitive traffic can be well transmitted in small, fixed size cells
- Fixed sized cells well suited for the PON TDMA upstream traffic
 - Easy to handle time slots, no collisions

Why ATM is not (really) used?

- Very popular at the beginning of the 90's
 - More and more multimedia traffic, with QoS requirements
- **Drawbacks**
 - Too much overhead with the headers
 - Ethernet – 14 byte / 1500 byte (~ 1%)
 - ATM – 5 byte / 53 byte (~ 10%)
 - Fragmentation and reassembly (SAR) too complicated
 - High speed ATM cards too expensive, compared to similar speed Ethernet cards
 - On 10 Gbps Ethernet, instead of 1.2 ms, only 1.2 μ s is the sending time of a 1500 byte frame
 - With such speeds, no need to worry about QoS

EPON

- Data sent in IEEE 802.3 (Ethernet) frames
 - Variable size frames, between 64 and 1518 bytes
- How to handle TDMA-based upstream communication?
 - We might use maximum length slots
 - Any frame can fit in
 - Not efficient, too much bandwidth wasted
 - We might have fixed length slots, filled with several frames
 - More efficient
 - Hard to fill a fixed length slot with variable size frames

EPON downstream traffic

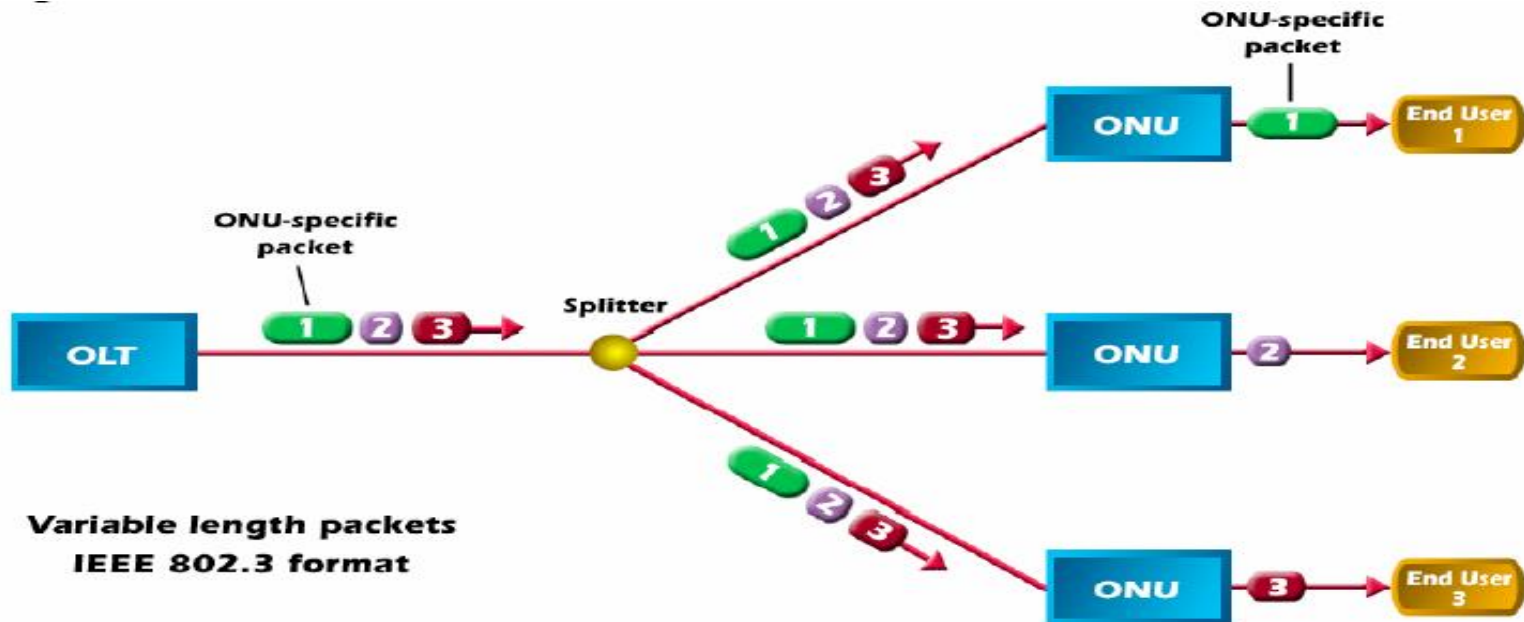

EPON downstream packets

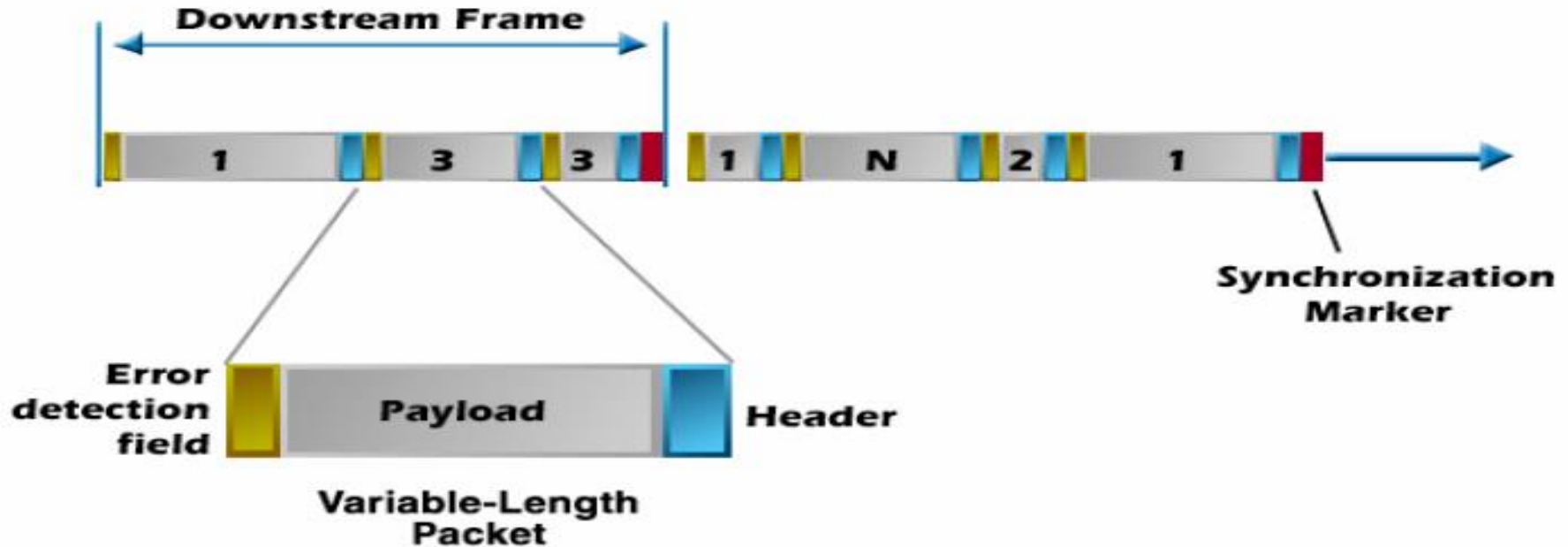

EPON upstream traffic

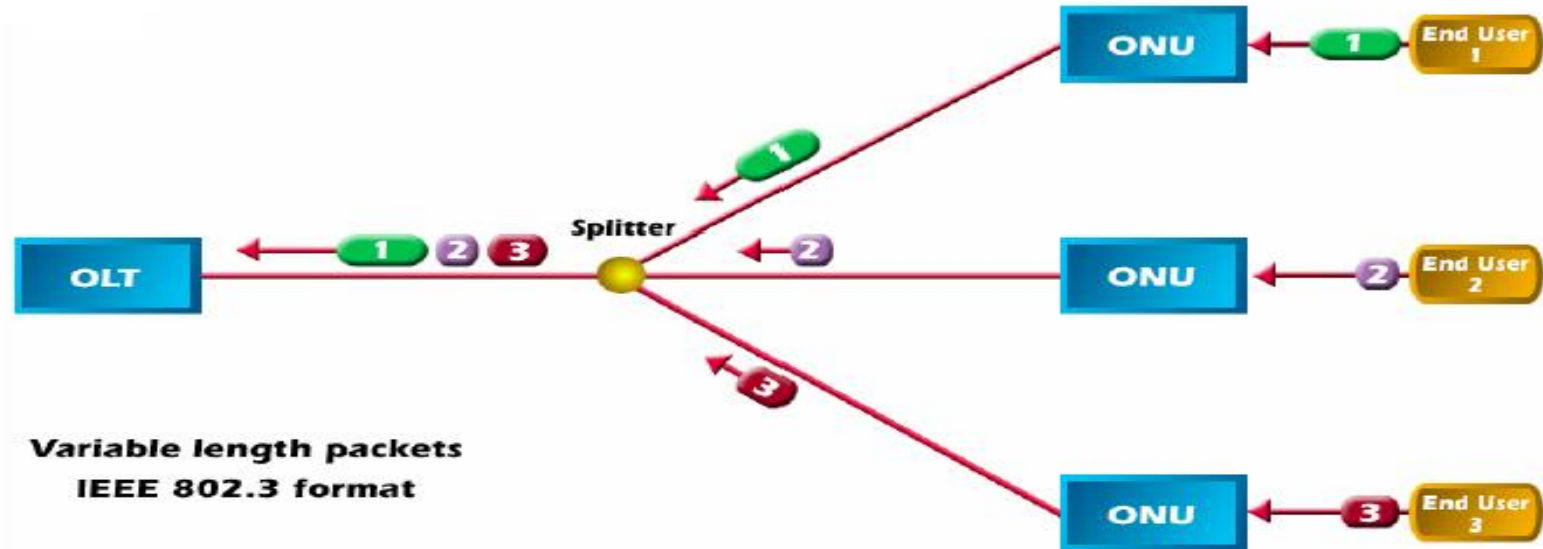

EPON upstream packets

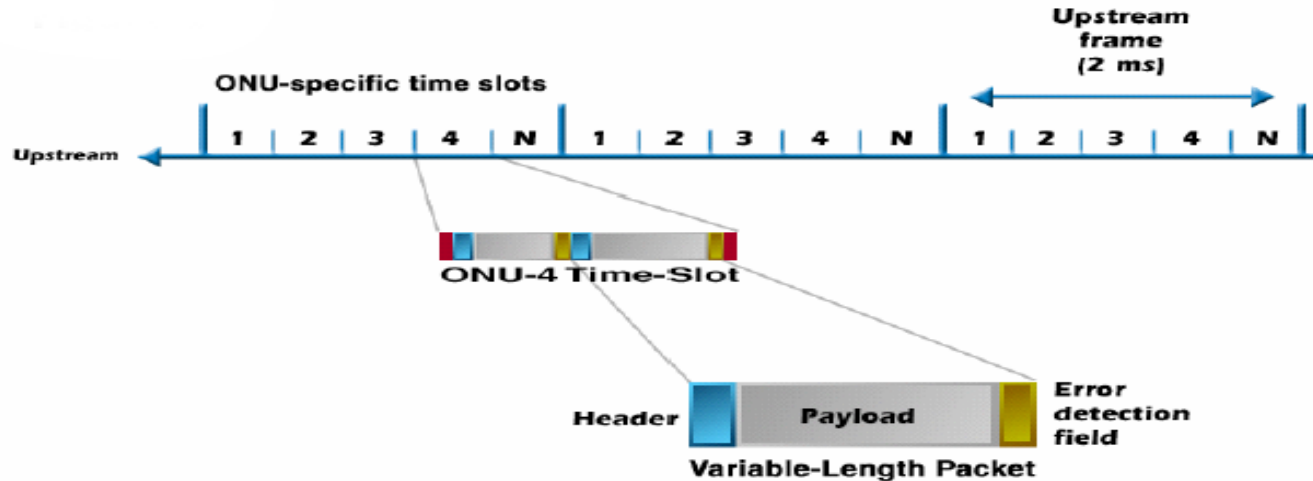

- The upstream traffic divided to frames
- Each ONU has its own time slot, that it fills with his own variable length packets

Traditional PON

- Main idea:
 - Its is not worth having a separate fiber for each user from the OLT
 - Bring on fiber close to the subscribers, and share it with passive devices
- Drawbacks
 - Splitters are dummy devices, cannot be controlled remotely
 - If a problem occurs, splitters has to be checked one by one
 - Not flexible
 - A 5th subscriber cannot be added to a 4-line splitter
 - The networks should be designed with over-provisioning in mind
- Solution: plan the network with larger splitters
 - Place for extensions
 - The subscribers will have to cover the costs

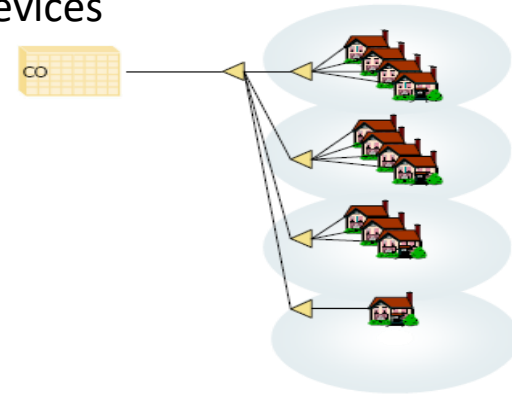

Passive Star PON

- Splitters in the same box
 - Easier to discover the faulty splitter
- Still a tree topology
 - If the connection between the splitter and the Central Office is cut, no backup

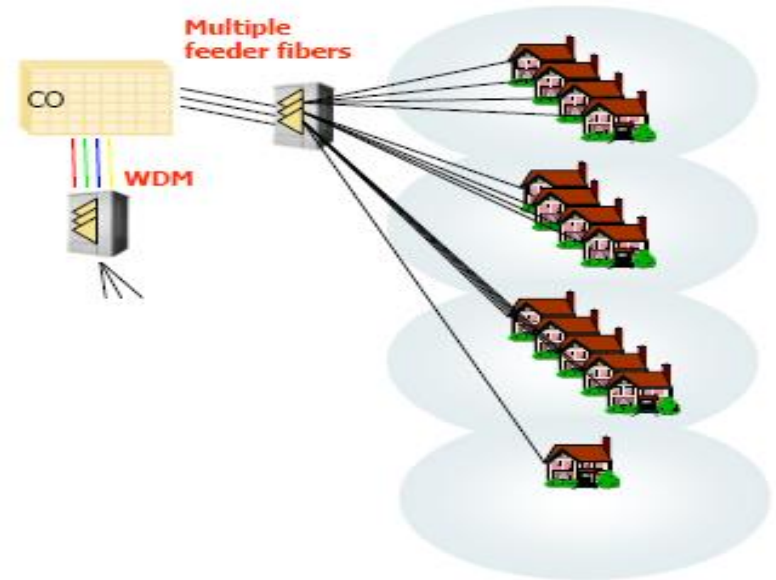

Active Star

- Drawback: need for powered active nodes
- Using intelligent devices at the edge of the network has many advantages
 - The active node can act as an IGMP proxy for multicast traffic
 - Detailed in a later course
 - Fault-tolerant solution
 - Active nodes joined in a ring
 - Ethernet Protection Switching Rings (EPSR)
 - 50 ms switching time in case of an error
 - Minor image quality degradation for a video stream
 - A phone conversation is not interrupted
 - Easy to manage, easy to repair

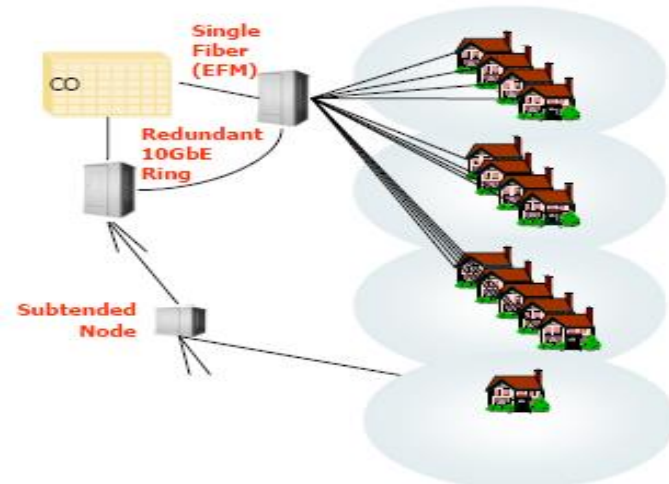

BPON

- Broadband PON
 - ATM-based
 - Better than traditional APON
 - Higher transmission speed
 - DBA – Dynamic Bandwidth Allocation
 - Security enhancements

GPON

- Gigabit PON
 - ITU-T G.984 standard
 - Several downstream/upstream versions
 - Most popular - 2.48 Gbps downstream, 1.244 Gbps upstream

WDM-PON

- WDM – Wavelength Division Multiplexing
 - Several wavelengths (colors, frequencies) on the same fiber
 - Up to 160 colors
 - On a 10 Gbit/s fiber, speed of 1.6 Tbit/s

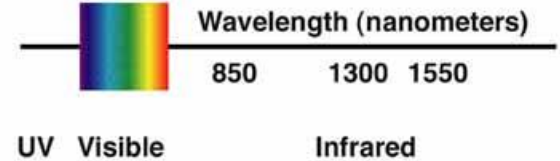

- WDM-PON
 - Combines the advantages of TDM-PON and AON
 - Virtual P2P connection for each ONU
 - Lower delay than in TDM-PON

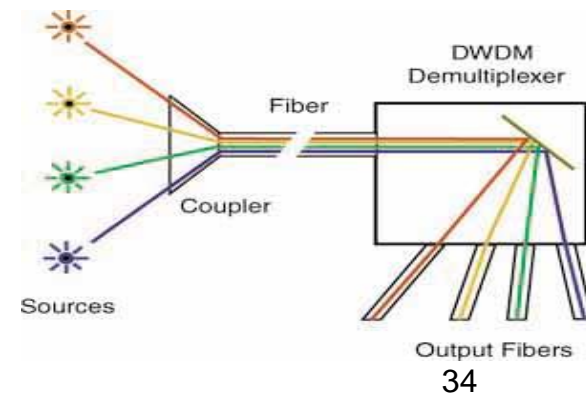

WDM-PON versions

- No standardized solution
 - We can have dedicated uplink and downlink wavelength for each ONU
 - We can allocate adaptively wavelengths to ONUs, based on their actual needs – adaptive lasers
 - We can have many ONUs over the same wavelength, and use TDM
 - Composite PON (CPON) – WDM technology for downstream, TDMA for upstream

Comparison of transfer speeds

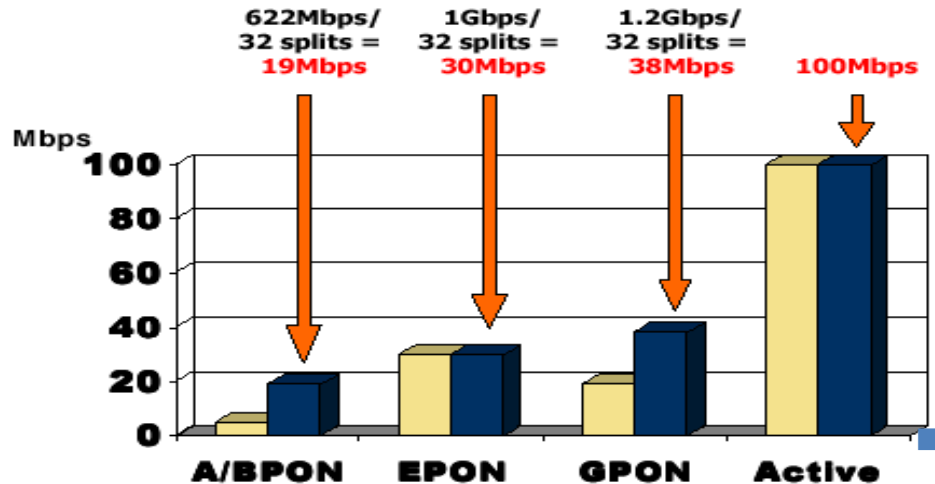

- With PON, slower speeds
 - Shared segment between the OLT and the first splitter
 - Situation is better if splitters are not fully loaded
 - Shared between 16 or 24 subscribers, not 32



If Active Nodes, each subscriber has his own fiber

- Individual users usually 100 Mbps in the two directions
- Business subscribers – up to 1 Gbps